



Hand Crank Operated  
Between Jamb Mounted

Page#:

Page 1

LG - Left Guide  
RG - Right Guide  
B - Bracket  
GW - Guide Width  
GD - Guide Depth

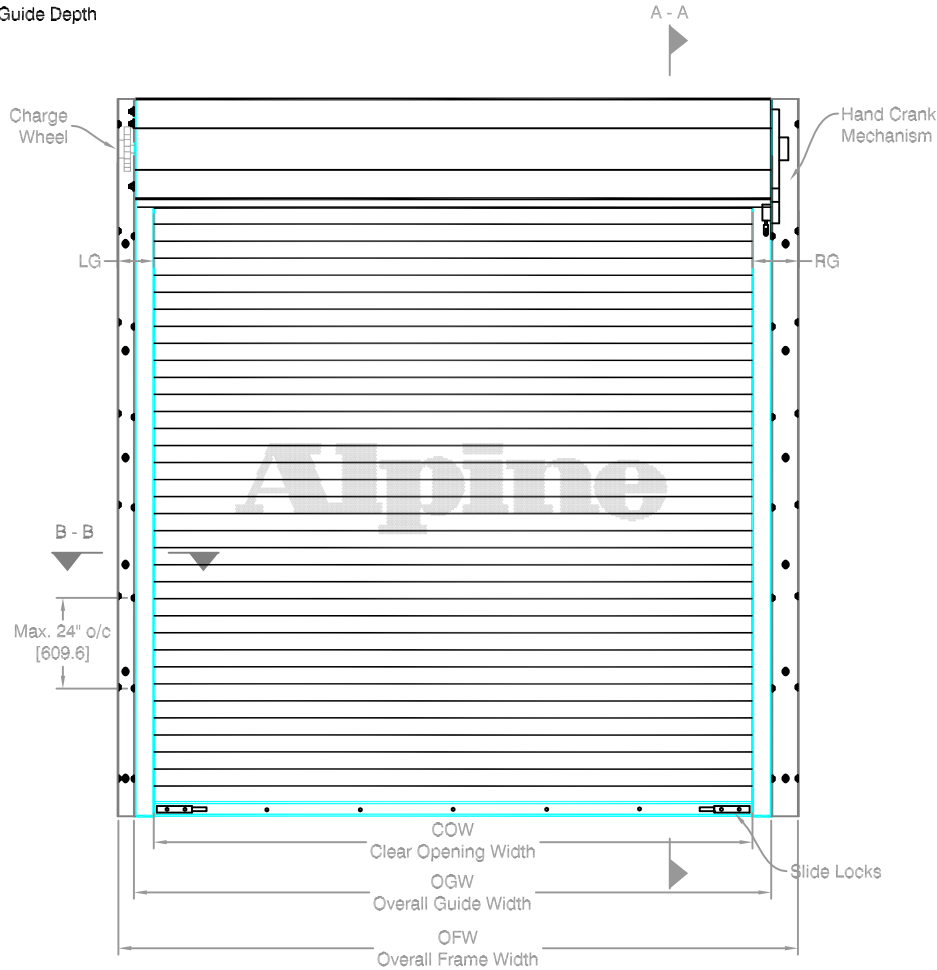

**COIL SIDE ELEVATION**

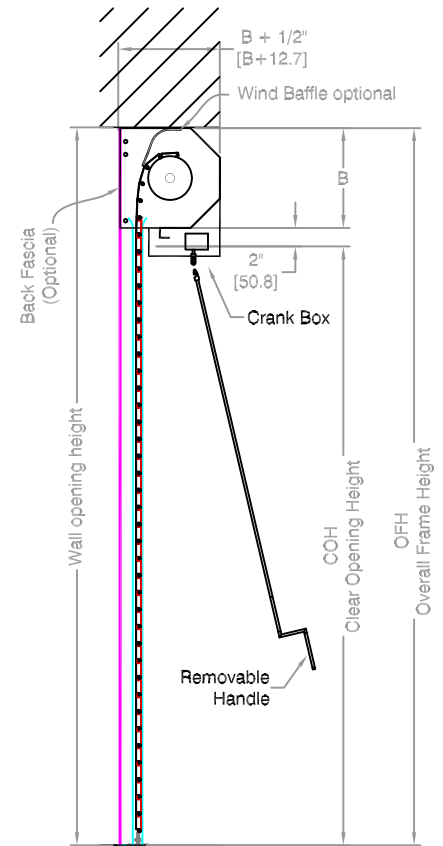

**VERTICAL SECTION A - A**

STEEL MOUNTED

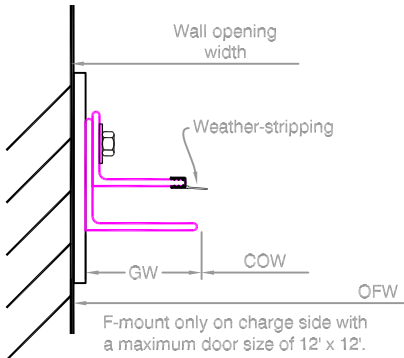

PACKOUT MOUNTED

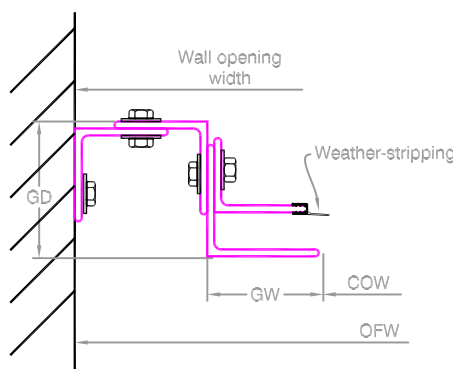

TUBE MOUNTED

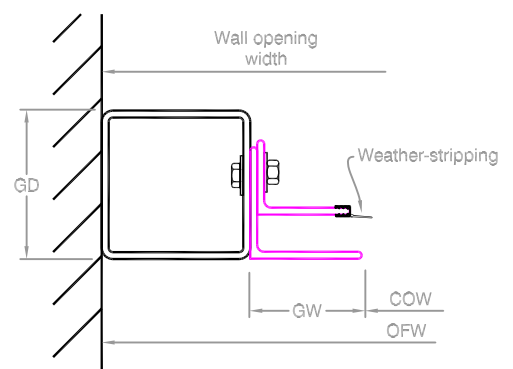

**GUIDE SECTION B - B**

**Notes:**

1. See page 2 for more options.
2. All metric conversions of dimensions are shown in brackets [ ].

SALES REP:

CUSTOMER:

JOB NAME:

NUMBER:

Manufactured by:



8 HULSE ROAD EAST SETAUKET, N.Y. 11733  
TEL: (631)473-9300 FAX: (631)642-0800  
© COPYRIGHT MAR 2007



Hand Crank Operated  
Between Jamb Mounted

Page#:

Page 2

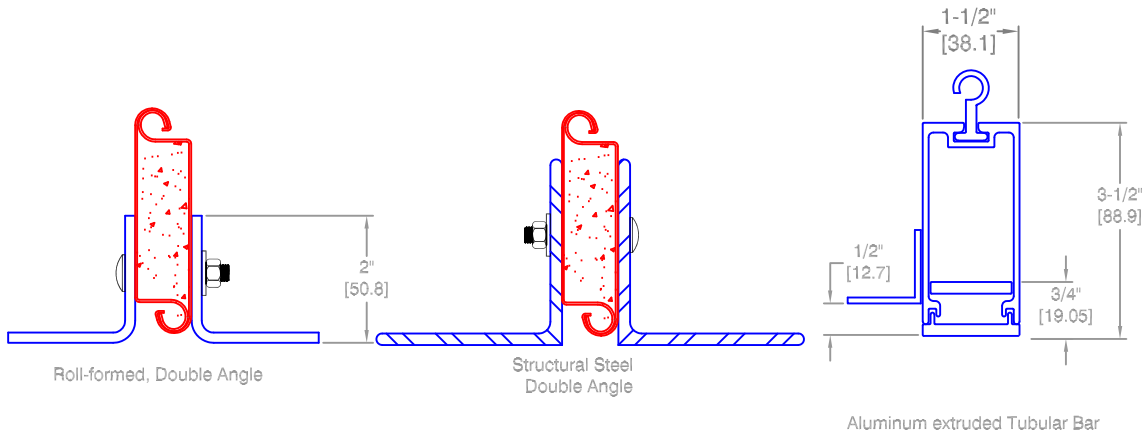

## BOTTOM BAR DETAIL

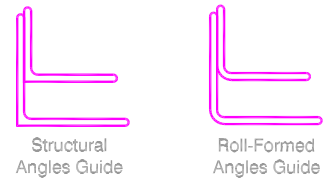
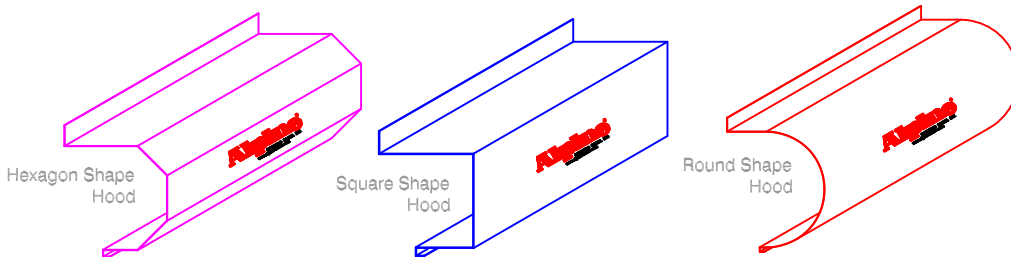

## HOOD SHAPES AVAILABLE FOR THIS DOOR

## GUIDE OPTIONS

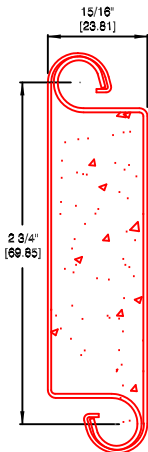

IMB V8 roll formed IMB flat slat sections  
w/ styrofoam insulation



Neoprene Astragal

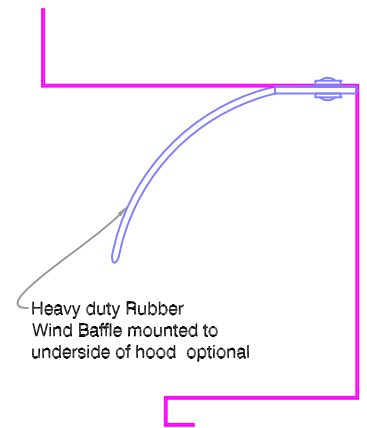

## CURTAIN DETAIL

## OBSTACLE EDGES AVAILABLE

## WIND BAFFLE DETAIL

Distributed By:

Call your Alpine representative for additional options and safety products to help find the best Alpine door to suit your needs.

Manufactured by:



8 HULSE ROAD EAST SETAUKET, N.Y. 11733  
TEL: (631)473-9300 FAX: (631)642-0800  
© COPYRIGHT MAY 2007

NOTE: MAXIMUM PIPE DEFLECTION ON ANY SIZE DOOR IS .034



Page#:

Page 3

Finding the minimum required operation for the size door you need.

Operator Legend

- Manual Push Up Operation
- Hand Crank Operation
- Hand Crank w/ Gear reduced 48
- Hand Crank w/ Gear reduced 60
- Motor Operation Only

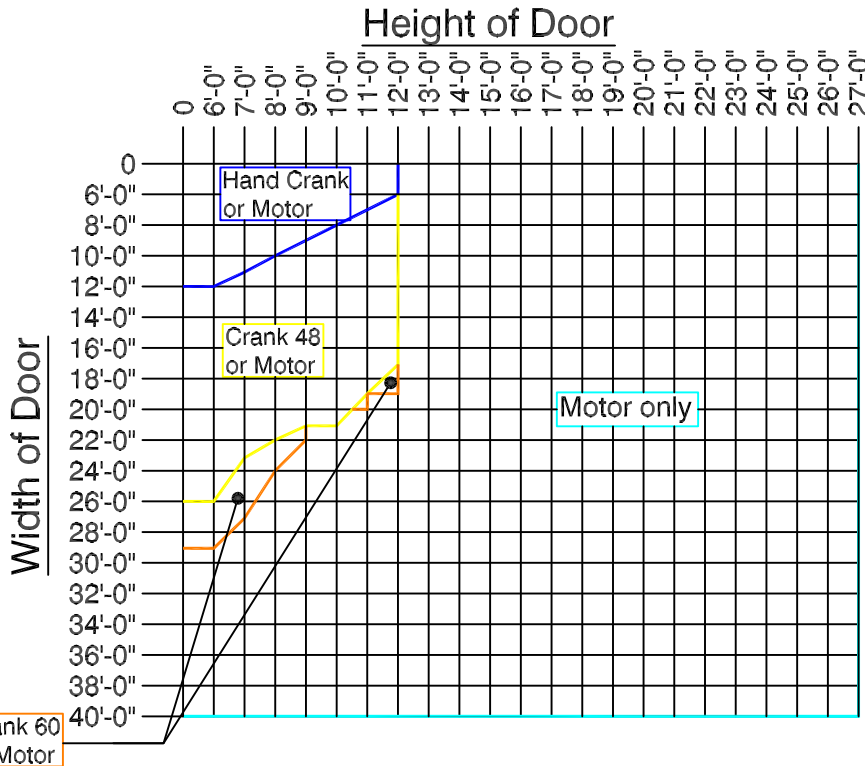

To use Chart: Find where your door width and height meet to find the minimum operation that may be used for that door size.

For example: The blue line indicates a Hand Crank Operation. Any size door on that line or above that line may use a Hand Crank, including the door sizes that fall into the Manual push up door. But, The Manual push up door may not be used for any door size below the line representing Push up operation. For any door size larger than what is represented here please consult your Alpine Overhead Doors, Inc. Factory. This Graph is for reference only, subject to change without notice.

Finding the minimum required bracket size for the door you need.

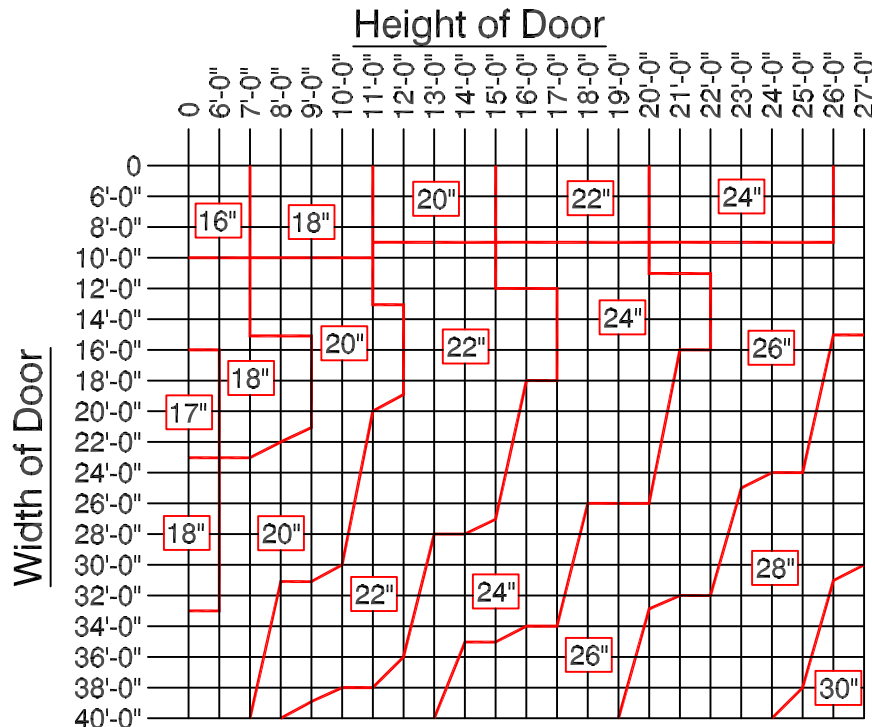

NOTE: Bracket sizes may vary based on gauge of curtain. Bracket size is directly related to the pipe low moment arm deflection (not more than .03 inches per foot).

To use Chart: Find where your door width and height meet to find the minimum bracket size for your door. For any door size larger than what is represented here please consult your Alpine Overhead Doors, Inc. Factory. This Graph is for reference only, subject to change without notice.

Distributed By:

Manufactured by:



8 HULSE ROAD EAST SETAUKET, N.Y. 11733  
 TEL: (631)473-9300 FAX: (631)642-0800  
 © COPYRIGHT DEC 2006