

Economical Series Grille

Grille Panel Door



Motor Operated
Between Jamb Mounted

Page #:

Page 1

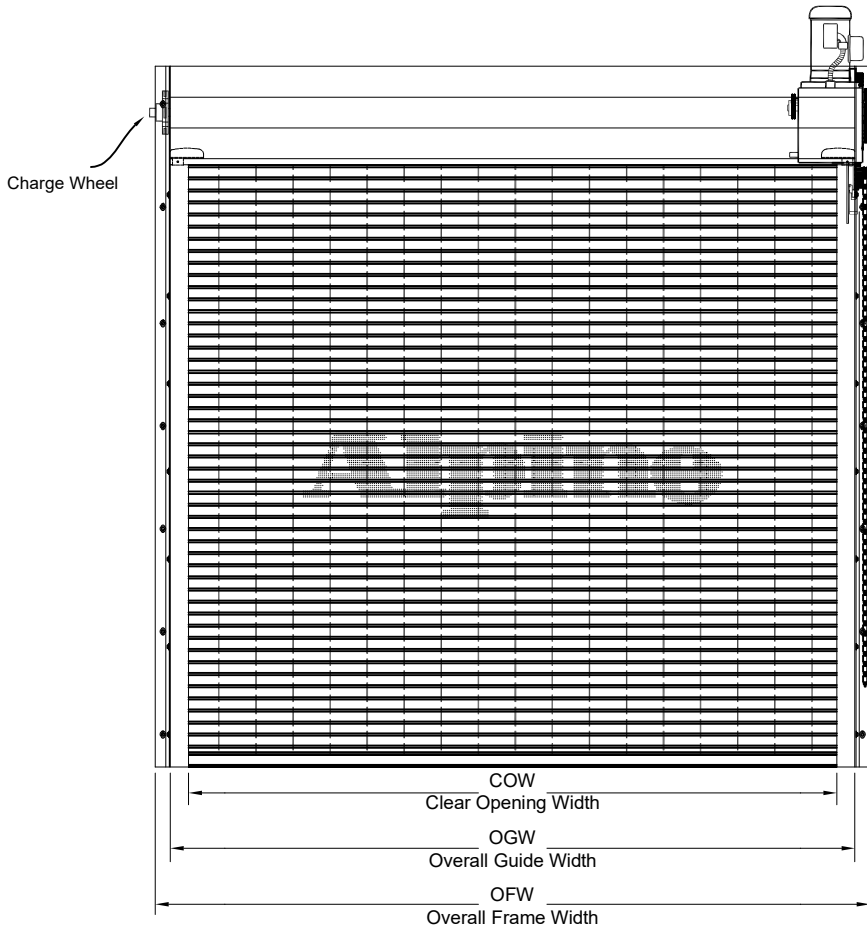

COIL SIDE ELEVATION

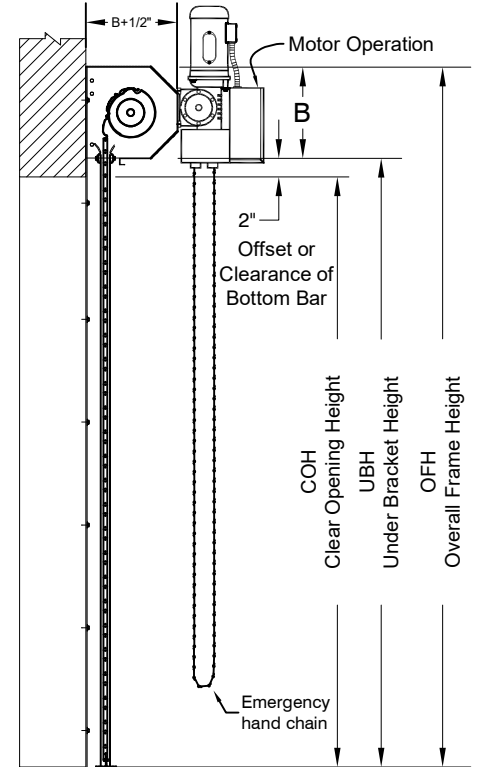

VERTICAL SECTION

BETWEEN JAMB MOUNTED (PACKOUT)

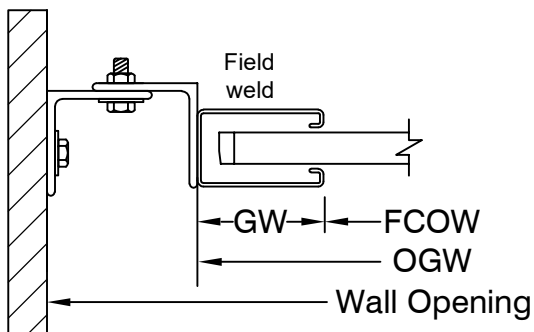

BETWEEN TUBE MOUNTED

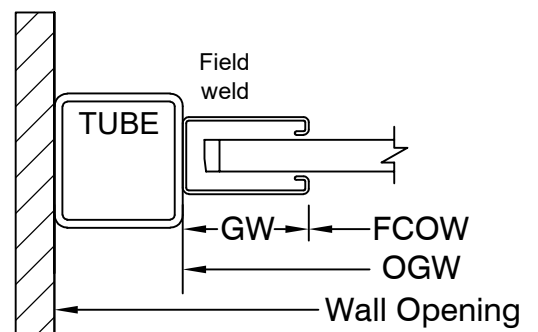

GUIDE SECTION

Notes:

1. See page 2 for more options.

SALES REP.:

CUSTOMER:

JOB NAME:

NUMBER:

Manufactured by:



OVERHEAD DOORS, INC.
8 HULSE RD. E. SETAUKET, N.Y. 11733
TEL: (631)473-9300 FAX: (631)642-0800
© COPYRIGHT January 2021
www.alpinedoors.com

Economical Series Grille

Grille Panel Door



Motor Operated
Face of Wall Mounted

Page #:

Page 2

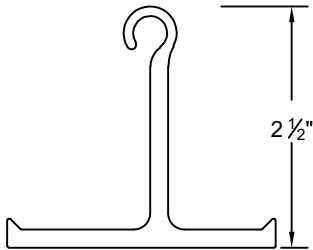

BOTTOM BAR DETAIL

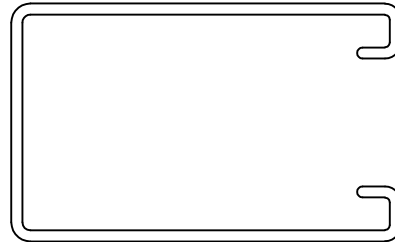

GUIDE DETAIL

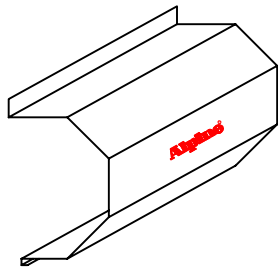

Hexagon Hood

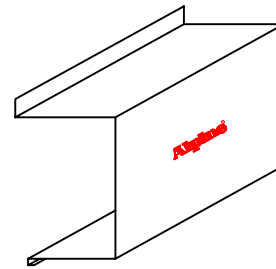

Square Hood

HOOD SHAPES AVAILABLE FOR THIS DOOR

Brick Pattern

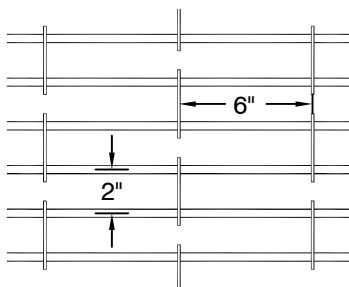

Straight Pattern

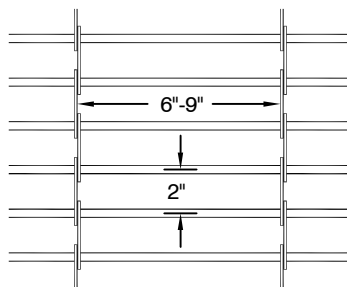

Continous Pattern

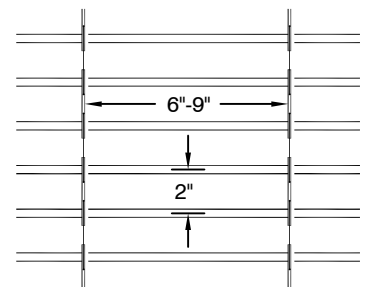

GRILLE CURTAIN OPTIONS

Call your Alpine representative for additional options and safety products to help find the best Alpine door to suit your needs.

Manufactured by:



OVERHEAD DOORS, INC.
8 HULSE RD. E. SETAUKET, N.Y. 11733
TEL: (631)473-9300 FAX: (631)642-0800
© COPYRIGHT January 2021
www.alpinedoors.com