

Counter-Shutter Door



Hand Crank Operated
Face of Wall Mounted

Page#:

Page 1

LG - Left Guide
RG - Right Guide
B - Bracket
GW - Guide Width
GD - Guide Depth

A - A

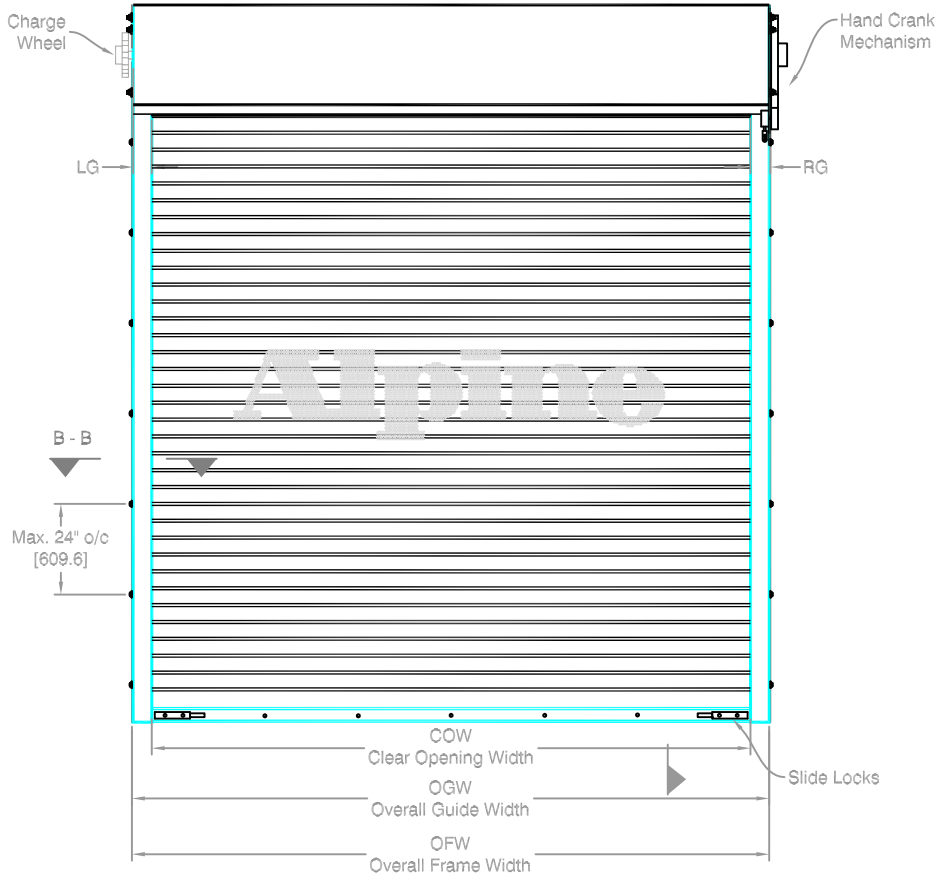

COIL SIDE ELEVATION

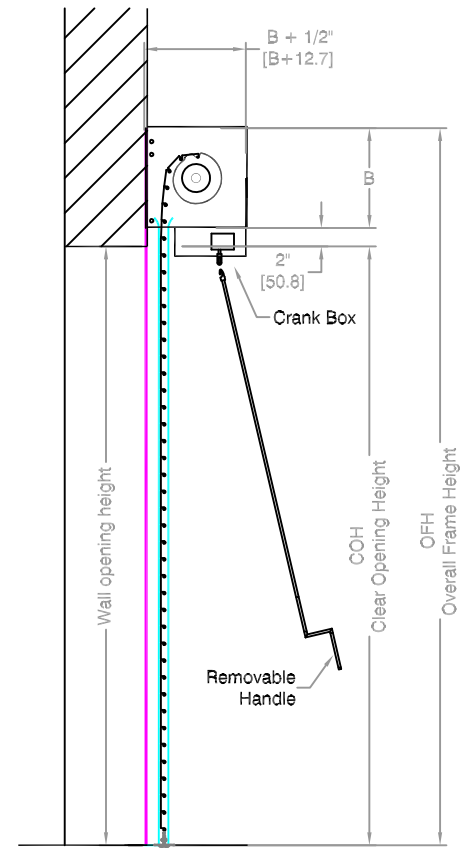

VERTICAL SECTION A - A

FACE MOUNTED TO MASONRY

FACE MOUNTED TO STEEL

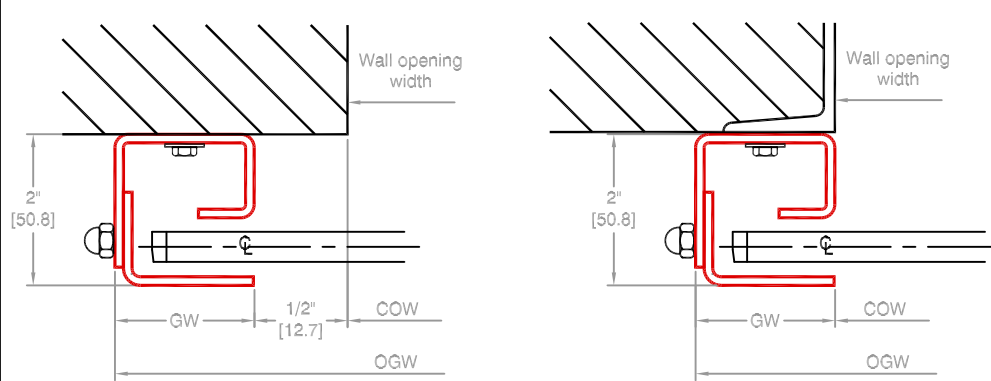

GUIDE SECTION B - B

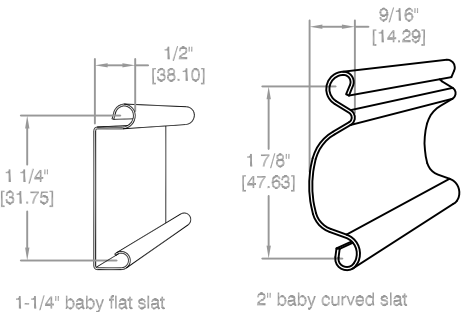

SLAT OPTIONS

CURTAIN DETAIL

Notes:

1. See page 2 for more options.
2. All metric conversions of dimensions are shown in brackets [].

SALES REP:

CUSTOMER:

JOB NAME:

NUMBER:

Manufactured by:



8 HULSE ROAD EAST SETAUKET, N.Y. 11733
TEL: (631)473-9300 FAX: (631)642-0800
© COPYRIGHT MAY 2007

Counter-Shutter Door



Hand Crank Operated
Face of Wall Mounted

Page#:

Page 2

NOTE: Shown here with the 1-1/4" Baby Flat Slat, the 2" Baby Curved Slat is attached similarly.

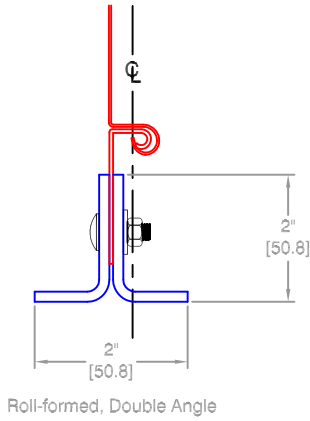

Roll-formed, Double Angle

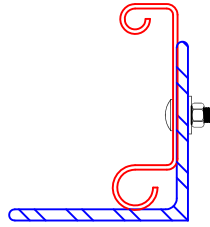

Single Angle

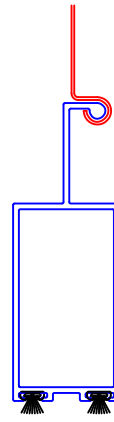

Aluminum extruded Tubular Bar

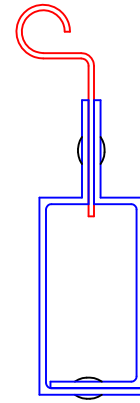

Tubular Bar (Lazer Cut)
Doors up to 8' wide

BOTTOM BAR OPTIONS AVAILABLE FOR THIS DOOR



Neoprene Astragal

Guides available for the 1-1/4" baby flat slat

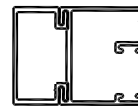

Aluminum Box Shutter Guide

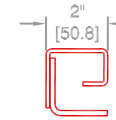

0' to 3'-11" doors

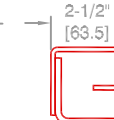

4' to 8' doors

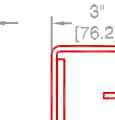

8' to 12' doors

Guides available for the 2" baby curved slat

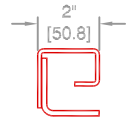

0' to 3'-11" doors

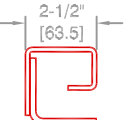

4' to 8' doors

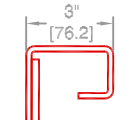

8' to 12' doors

OPTIONAL EDGES AVAILABLE

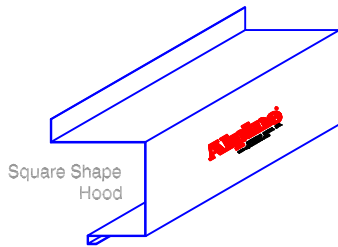

Square Shape Hood

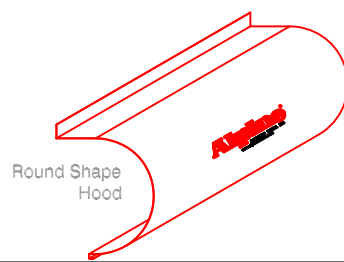

Round Shape Hood

HOOD SHAPES AVAILABLE FOR THIS DOOR

Distributed By:

Call your Alpine representative for additional options and safety products to help find the best Alpine door to suit your needs.

Manufactured by:



8 HULSE ROAD EAST SETAUKET, N.Y. 11733
TEL: (631)473-9300 FAX: (631)642-0800
© COPYRIGHT MAY 2007

NOTE: MAXIMUM PIPE DEFLECTION ON ANY SIZE DOOR IS .034



Page#:

Page 3

Finding the minimum required operation for the size door you need.

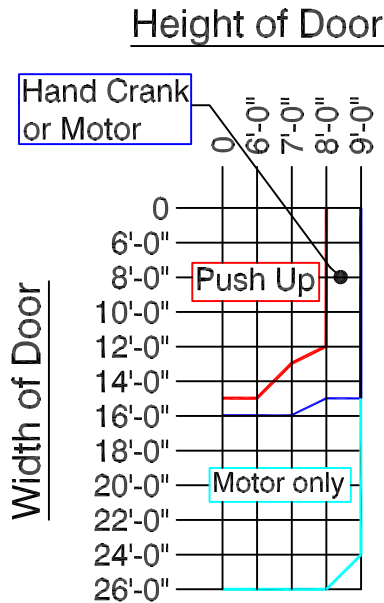

Operator Legend

- Manual Push Up Operation
- Hand Crank Operation
- Motor Operation Only

To use Chart: Find where your door width and height meet to find the minimum operation that may be used for that door size.

For example: The blue line indicates a Hand Crank Operation. Any size door on that line or above that line may use a Hand Crank, including the door sizes that fall into the Manual push up door. But, The Manual push up door may not be used for any door size below the line representing Push up operation. For any door size larger than what is represented here please consult your Alpine Overhead Doors, Inc. Factory. This Graph is for reference only, subject to change without notice.

FOR LARGER SIZES CONSULT FACTORY.

Finding the minimum required bracket size for the door you need.

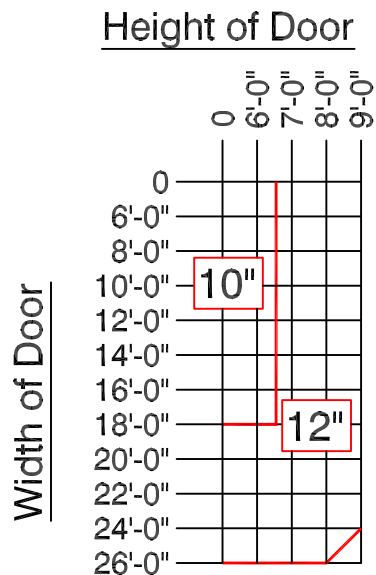

NOTE: Bracket sizes may vary based on gauge of curtain. Bracket size is directly related to the pipe low moment arm deflection (not more than .03 inches per foot).

To use Chart: Find where your door width and height meet to find the minimum bracket size for your door. For any door size larger than what is represented here please consult your Alpine Overhead Doors, Inc. Factory. This Graph is for reference only, subject to change without notice.

FOR LARGER SIZES CONSULT FACTORY.

Distributed By:

Manufactured by:

Alpine[®]
OVERHEAD DOORS, INC.

8 HULSE ROAD EAST SETAUKET, N.Y. 11733

TEL: (631)473-9300 FAX: (631)642-0800

© COPYRIGHT DEC 2006

NOTE: MAXIMUM PIPE DEFLECTION ON ANY SIZE DOOR IS .034



Page#:

Page 3

Finding the minimum required operation for the size door you need.

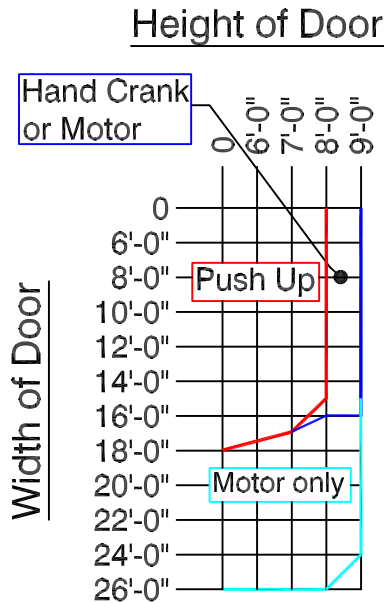

Operator Legend

- Manual Push Up Operation
- Hand Crank Operation
- Motor Operation Only

To use Chart: Find where your door width and height meet to find the minimum operation that may be used for that door size.

For example: The blue line indicates a Hand Crank Operation. Any size door on that line or above that line may use a Hand Crank, including the door sizes that fall into the Manual push up door. But, The Manual push up door may not be used for any door size below the line representing Push up operation. For any door size larger than what is represented here please consult your Alpine Overhead Doors, Inc. Factory. This Graph is for reference only, subject to change without notice.

FOR LARGER SIZES CONSULT FACTORY.

Finding the minimum required bracket size for the door you need.

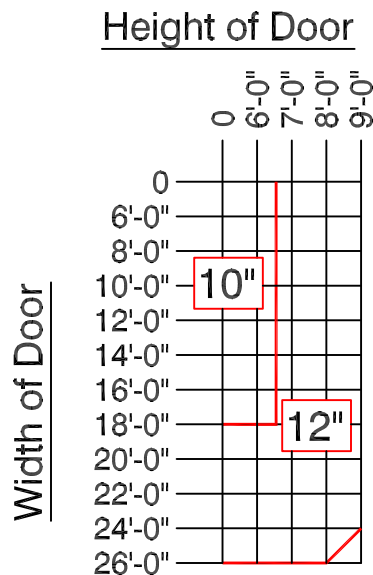

NOTE: Bracket sizes may vary based on gauge of curtain. Bracket size is directly related to the pipe low moment arm deflection (not more than .03 inches per foot).

To use Chart: Find where your door width and height meet to find the minimum bracket size for your door. For any door size larger than what is represented here please consult your Alpine Overhead Doors, Inc. Factory. This Graph is for reference only, subject to change without notice.

FOR LARGER SIZES CONSULT FACTORY.

Distributed By:

Manufactured by:

Alpine[®]
OVERHEAD DOORS, INC.

8 HULSE ROAD EAST SETAUKET, N.Y. 11733

TEL: (631)473-9300 FAX: (631)642-0800

© COPYRIGHT DEC 2006