

# Counter-Shutter Door



Motor Operated  
Face of Wall Mounted

Page#:

Page 1

LG - Left Guide  
RG - Right Guide  
B - Bracket  
GW - Guide Width  
GD - Guide Depth

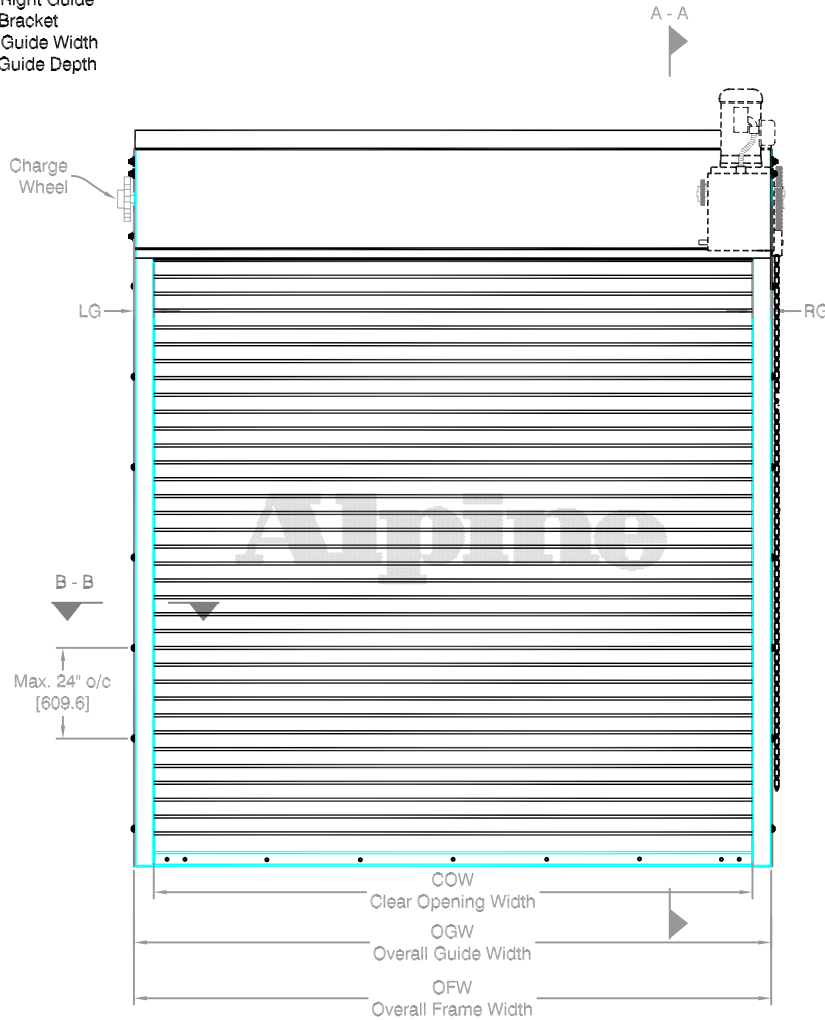

COIL SIDE ELEVATION

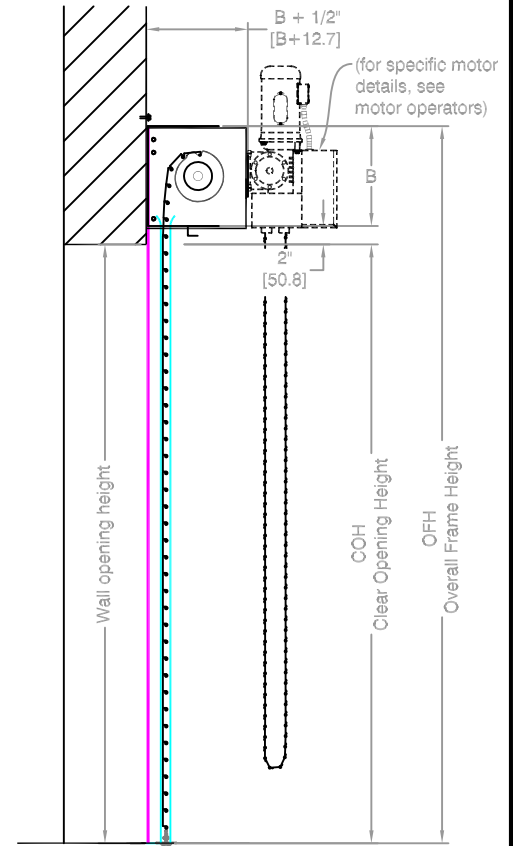

VERTICAL SECTION A - A

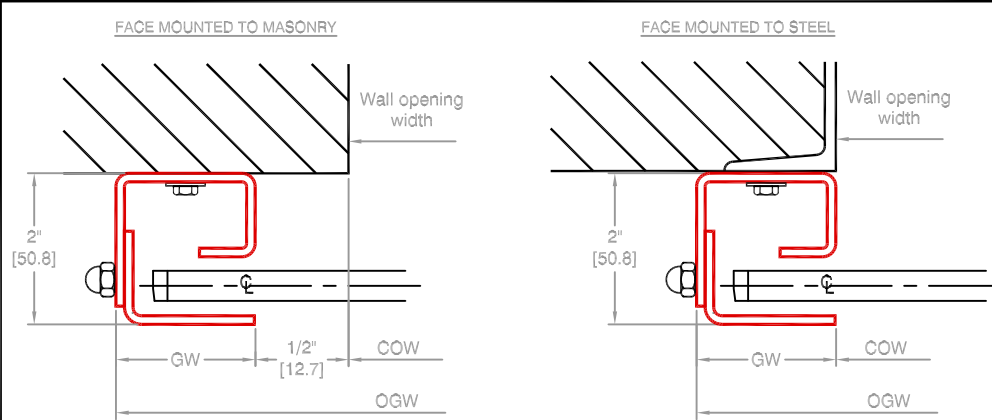

GUIDE SECTION B - B

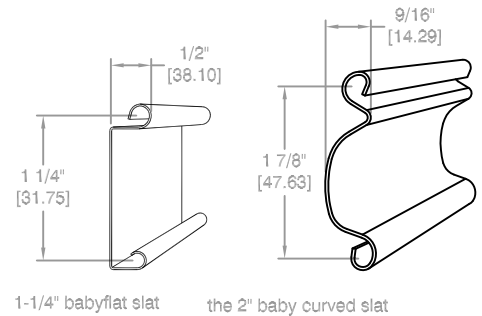

SLAT OPTIONS

Notes:

- See page 2 for more options.
- All metric conversions of dimensions are shown in brackets [ ].

SALES REP: \_\_\_\_\_

CUSTOMER: \_\_\_\_\_

JOB NAME: \_\_\_\_\_

NUMBER: \_\_\_\_\_

Manufactured by:

**Alpine**<sup>®</sup>  
OVERHEAD DOORS, INC.  
8 HULSE ROAD EAST SETAUKET, N.Y. 11733  
TEL: (631)473-9300 FAX: (631)642-0800  
© COPYRIGHT MAY 2007

CURTAIN DETAIL

# Counter-Shutter Door



Motor Operated  
Face of Wall Mounted

Page#:

Page 2

NOTE: Shown here with the 1-1/4" Baby Flat Slat, the 2" Baby Curved Slat is attached similarly.

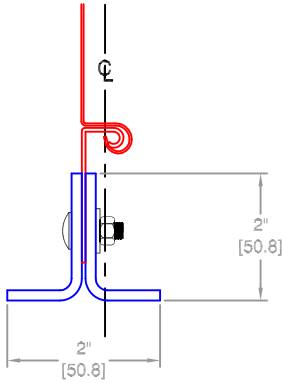

Roll-formed, Double Angle

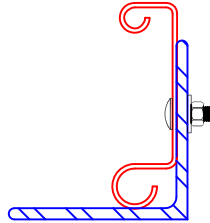

Single Angle

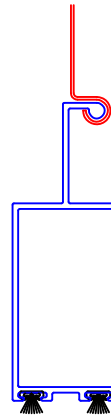

Aluminum extruded Tubular Bar

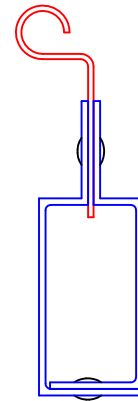

Tubular Bar (Lazer Cut)  
Doors up to 8' wide

## BOTTOM BAR OPTIONS AVAILABLE FOR THIS DOOR



Neoprene Astragal



Pneumatic Sensing Edge



Electric Sensing Edge

Guides available for the 1-1/4" baby flat slat

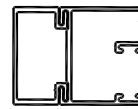

Aluminum Box Shutter Guide

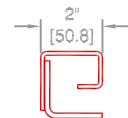

0' to 3'-11" doors  
"G" Shutter Guide

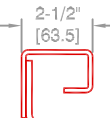

4' to 8' doors  
"G" Shutter Guide

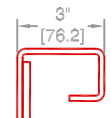

8' to 12' doors  
"G" Shutter Guide

Guides available for the 2" baby curved slat

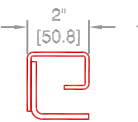

0' to 3'-11" doors  
"G" Shutter Guide

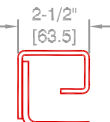

4' to 8' doors  
"G" Shutter Guide

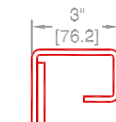

8' to 12' doors  
"G" Shutter Guide

## OBSTACLE EDGES AVAILABLE

## GUIDES AVAILABLE FOR THIS DOOR

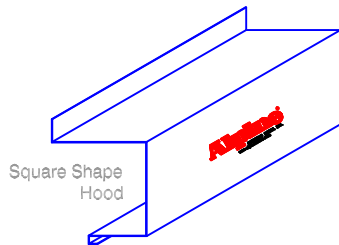

Square Shape Hood

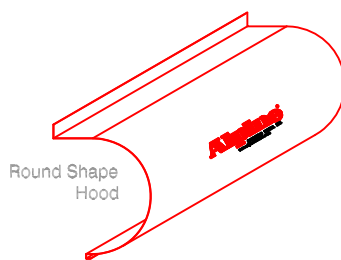

Round Shape Hood

## HOOD SHAPES AVAILABLE FOR THIS DOOR

Distributed By:

Call your Alpine representative for additional options and safety products to help find the best Alpine door to suit your needs.

Manufactured by:



8 HULSE ROAD EAST SETAUKET, N.Y. 11733  
TEL: (631)473-9300 FAX: (631)642-0800  
© COPYRIGHT MAY 2007

NOTE: MAXIMUM PIPE DEFLECTION ON ANY SIZE DOOR IS .034



Page#:

Page 3

## Finding the minimum required operation for the size door you need.

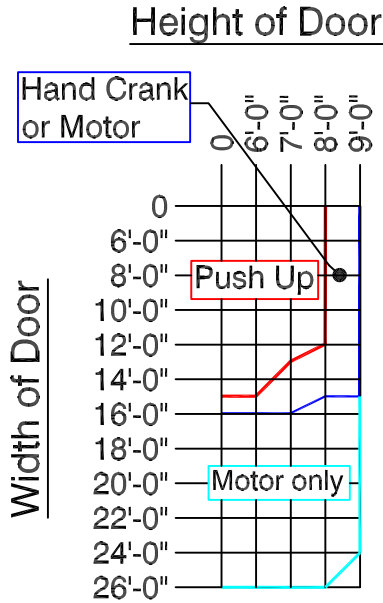

### Operator Legend

- Manual Push Up Operation
- Hand Crank Operation
- Motor Operation Only

To use Chart: Find where your door width and height meet to find the minimum operation that may be used for that door size.

For example: The blue line indicates a Hand Crank Operation. Any size door on that line or above that line may use a Hand Crank, including the door sizes that fall into the Manual push up door. But, The Manual push up door may not be used for any door size below the line representing Push up operation. For any door size larger than what is represented here please consult your Alpine Overhead Doors, Inc. Factory. This Graph is for reference only, subject to change without notice.

FOR LARGER SIZES CONSULT FACTORY.

## Finding the minimum required bracket size for the door you need.

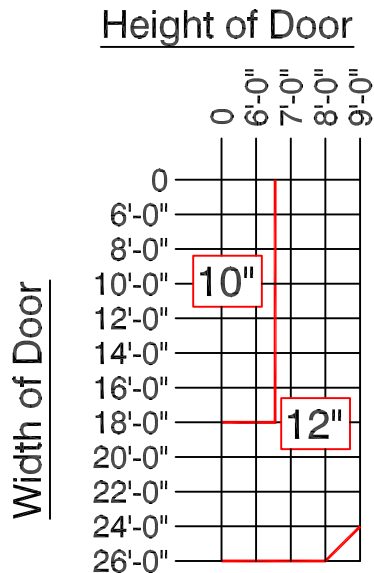

NOTE: Bracket sizes may vary based on gauge of curtain. Bracket size is directly related to the pipe low moment arm deflection (not more than .03 inches per foot).

To use Chart: Find where your door width and height meet to find the minimum bracket size for your door. For any door size larger than what is represented here please consult your Alpine Overhead Doors, Inc. Factory. This Graph is for reference only, subject to change without notice.

FOR LARGER SIZES CONSULT FACTORY.

Distributed By:

Manufactured by:

**Alpine**<sup>®</sup>  
OVERHEAD DOORS, INC.

8 HULSE ROAD EAST SETAUKET, N.Y. 11733

TEL: (631)473-9300 FAX: (631)642-0800

© COPYRIGHT DEC 2006

NOTE: MAXIMUM PIPE DEFLECTION ON ANY SIZE DOOR IS .034



Page#:

Page 3

## Finding the minimum required operation for the size door you need.

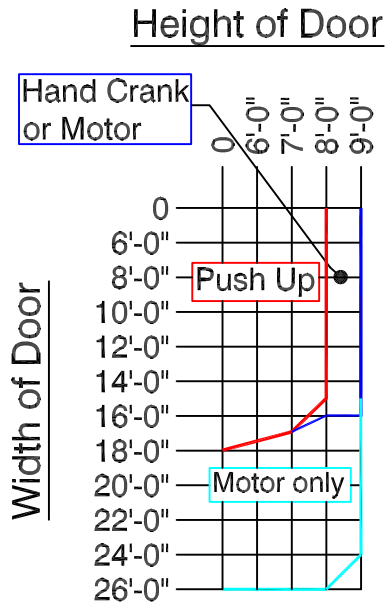

### Operator Legend

- Manual Push Up Operation
- Hand Crank Operation
- Motor Operation Only

To use Chart: Find where your door width and height meet to find the minimum operation that may be used for that door size.

For example: The blue line indicates a Hand Crank Operation. Any size door on that line or above that line may use a Hand Crank, including the door sizes that fall into the Manual push up door. But, The Manual push up door may not be used for any door size below the line representing Push up operation. For any door size larger than what is represented here please consult your Alpine Overhead Doors, Inc. Factory. This Graph is for reference only, subject to change without notice.

FOR LARGER SIZES CONSULT FACTORY.

## Finding the minimum required bracket size for the door you need.

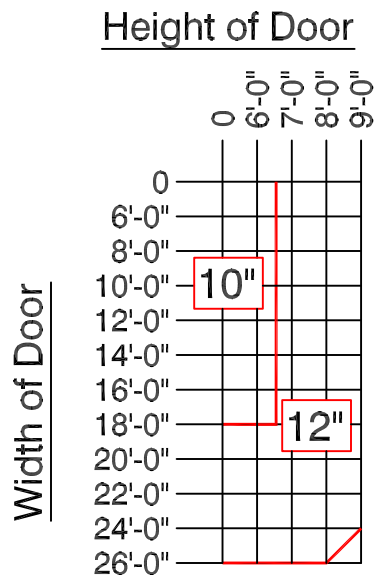

NOTE: Bracket sizes may vary based on gauge of curtain. Bracket size is directly related to the pipe low moment arm deflection (not more than .03 inches per foot).

To use Chart: Find where your door width and height meet to find the minimum bracket size for your door. For any door size larger than what is represented here please consult your Alpine Overhead Doors, Inc. Factory. This Graph is for reference only, subject to change without notice.

FOR LARGER SIZES CONSULT FACTORY.

Distributed By:

Manufactured by:

**Alpine**<sup>®</sup>  
OVERHEAD DOORS, INC.

8 HULSE ROAD EAST SETAUKET, N.Y. 11733

TEL: (631)473-9300 FAX: (631)642-0800

© COPYRIGHT DEC 2006