

# QUALITY ROLLING GRILLE DOORS

# Straight or Brick Pattern



**Industrial-Grille<sup>™</sup>**  
**QUALITY ROLLING GRILLE DOORS**

Hand Crank Operated  
 Face of Wall Mounted

Page#:

Page 1

- LG - Left Guide
- RG - Right Guide
- B - Bracket
- GW - Guide Width
- GD - Guide Depth

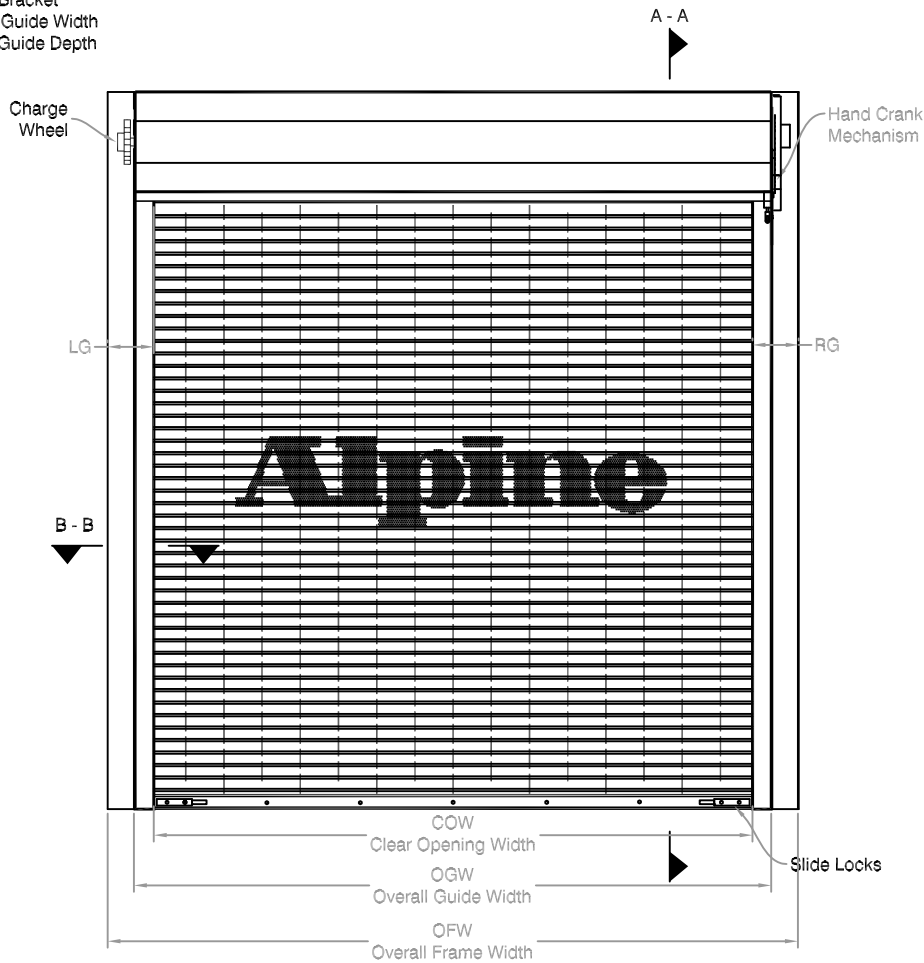

**COIL SIDE ELEVATION**

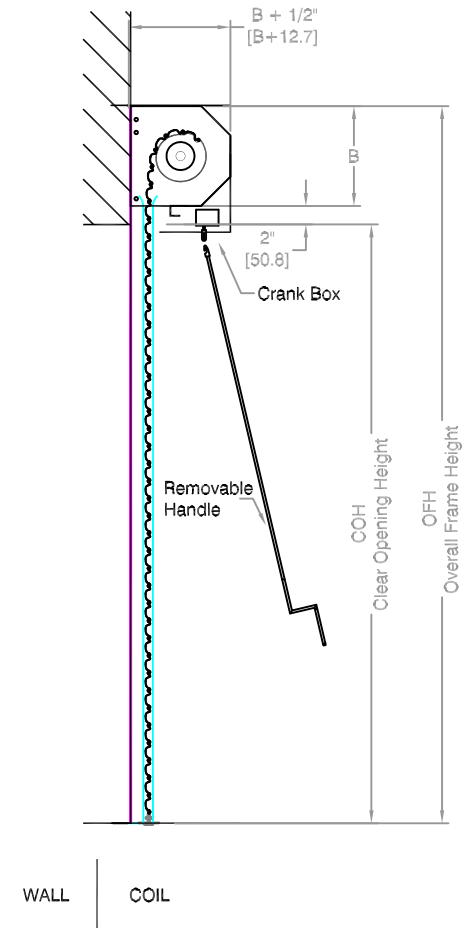

**VERTICAL SECTION A - A**

FACE MOUNTED TO MASONRY

FACE MOUNTED TO STEEL

FACE MOUNTED TO TUBE

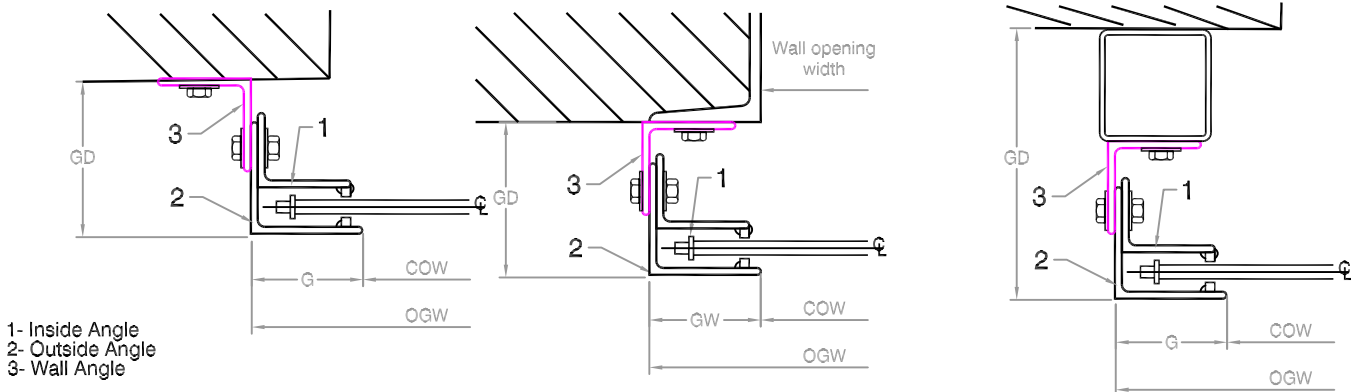

- 1- Inside Angle
- 2- Outside Angle
- 3- Wall Angle

**GUIDE SECTION B - B**

**Notes:**

- 1. See page 2 for more options.
- 2. All metric conversions of dimensions are shown in brackets [ ].

SALES REP:

CUSTOMER:

JOB NAME:

NUMBER:

Manufactured by:



8 HULSE ROAD EAST SETAUKET, N.Y. 11733  
 TEL: (631)473-9300 FAX: (631)642-0800  
 © COPYRIGHT JAN 2007

# QUALITY ROLLING GRILLE DOORS

Straight or Brick Pattern

**Industrial-Grille<sup>™</sup>**

QUALITY ROLLING GRILLE DOORS

Hand Crank Operated  
Face of Wall Mounted

Page#:

Page 2

4 1/2", 6" or 9" Wide

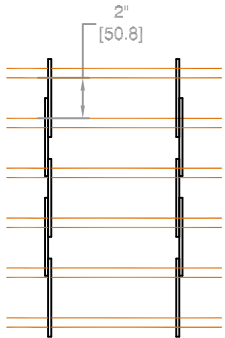

Straight Pattern

4 1/2" or 6" Wide

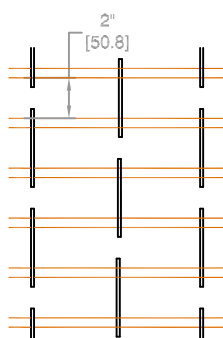

Brick Pattern



Neoprene Astragal

## CURTAIN OPTIONS

## OBSTACLE EDGES AVAILABLE

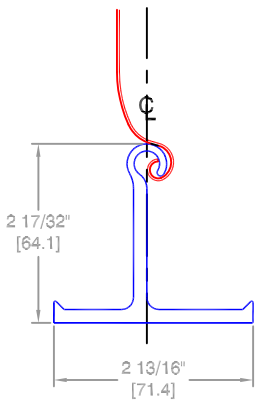

Aluminum extruded "T" bottom bar

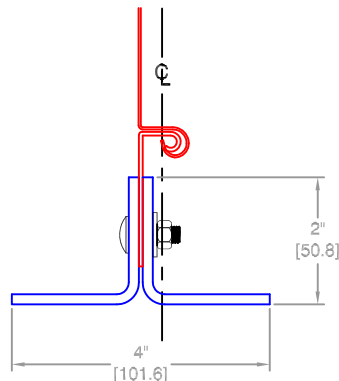

Roll-formed, Double Angle

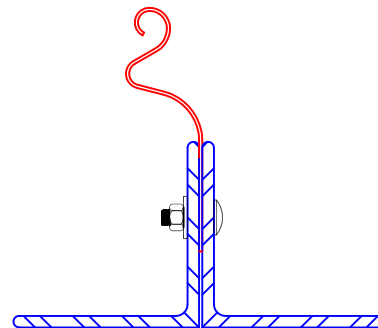

Structural Steel Double Angle

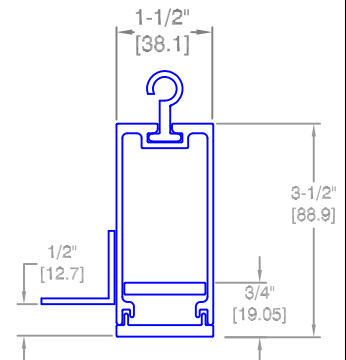

Aluminum extruded Tubular Bar

## BOTTOM BAR OPTIONS

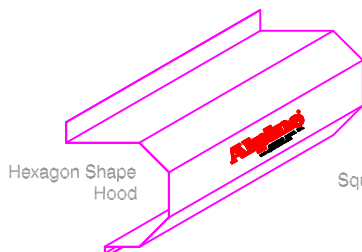

Hexagon Shape Hood

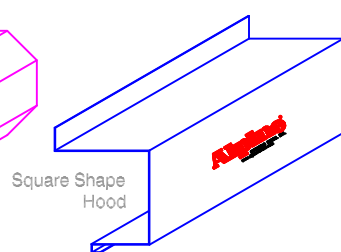

Square Shape Hood

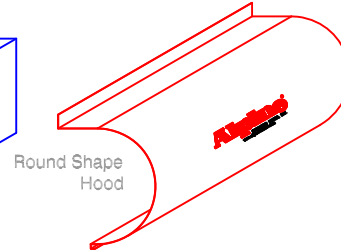

Round Shape Hood

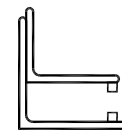

Structural Angles Guide

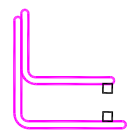

Roll-Formed Angles Guide

## HOOD SHAPE OPTIONS

## GUIDES OPTIONS

Distributed By:

Call your Alpine representative for additional options and safety products to help find the best Alpine door to suit your needs.

Manufactured by:

**Alpine<sup>®</sup>**  
OVERHEAD DOORS, INC.

8 HULSE ROAD EAST SETAUKET, N.Y. 11733

TEL: (631)473-9300 FAX: (631)642-0800

© COPYRIGHT MAY 2007

NOTE: MAXIMUM PIPE DEFLECTION ON ANY SIZE DOOR IS .034

Finding the minimum required operation for the size door you need.

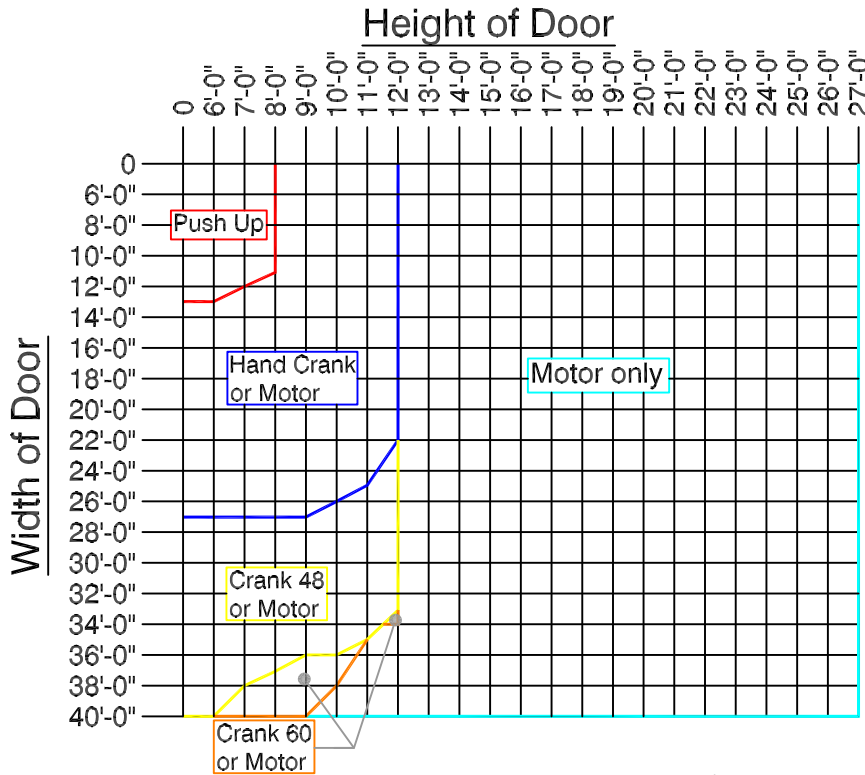

Operator Legend

- Manual Push Up Operation
- Hand Crank Operation
- Hand Crank w/ Gear reduced 48
- Hand Crank w/ Gear reduced 60
- Motor Operation Only

To use Chart: Find where your door width and height meet to find the minimum operation that may be used for that door size.

For example: The blue line indicates a Hand Crank Operation. Any size door on that line or above that line may use a Hand Crank, including the door sizes that fall into the Manual push up door. But, The Manual push up door may not be used for any door size below the line representing Push up operation. For any door size larger than what is represented here please consult your Alpine Overhead Doors, Inc. Factory. This Graph is for reference only, subject to change without notice.

Finding the minimum required bracket size for the door you need.

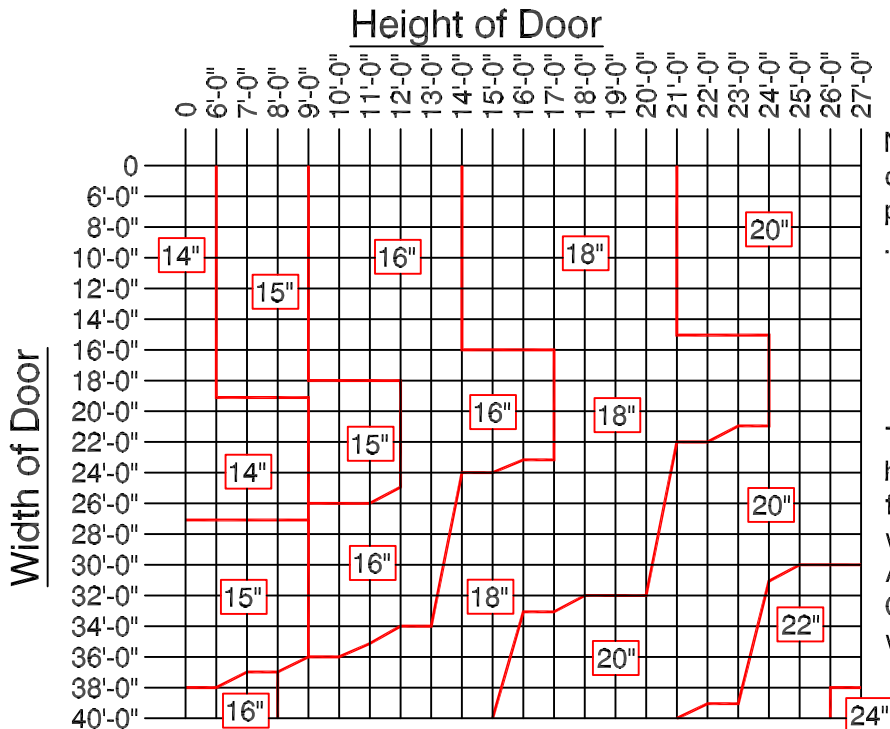

NOTE: Bracket sizes may vary based on gauge of curtain. Bracket size is directly related to the pipe low moment arm deflection (not more than .03 inches per foot).

To use Chart: Find where your door width and height meet to find the minimum bracket size for your door. For any door size larger than what is represented here please consult your Alpine Overhead Doors, Inc. Factory. This Graph is for reference only, subject to change without notice.

Distributed By:

Manufactured by:

**Alpine®**  
OVERHEAD DOORS, INC.  
8 HULSE ROAD EAST SETAUKET, N.Y. 11733  
TEL: (631)473-9300 FAX: (631)642-0800  
© COPYRIGHT DEC 2006