

SOUND RETARDANT DOOR

Insulated Slat



Patent # 5419386 ®
Insul-Sound
 SOUND RETARDANT DOOR

Motor Operated
 Between Jamb Mounted

Page#: Page 1

LG - Left Guide
 RG - Right Guide
 B - Bracket
 GW - Guide Width
 GD - Guide Depth

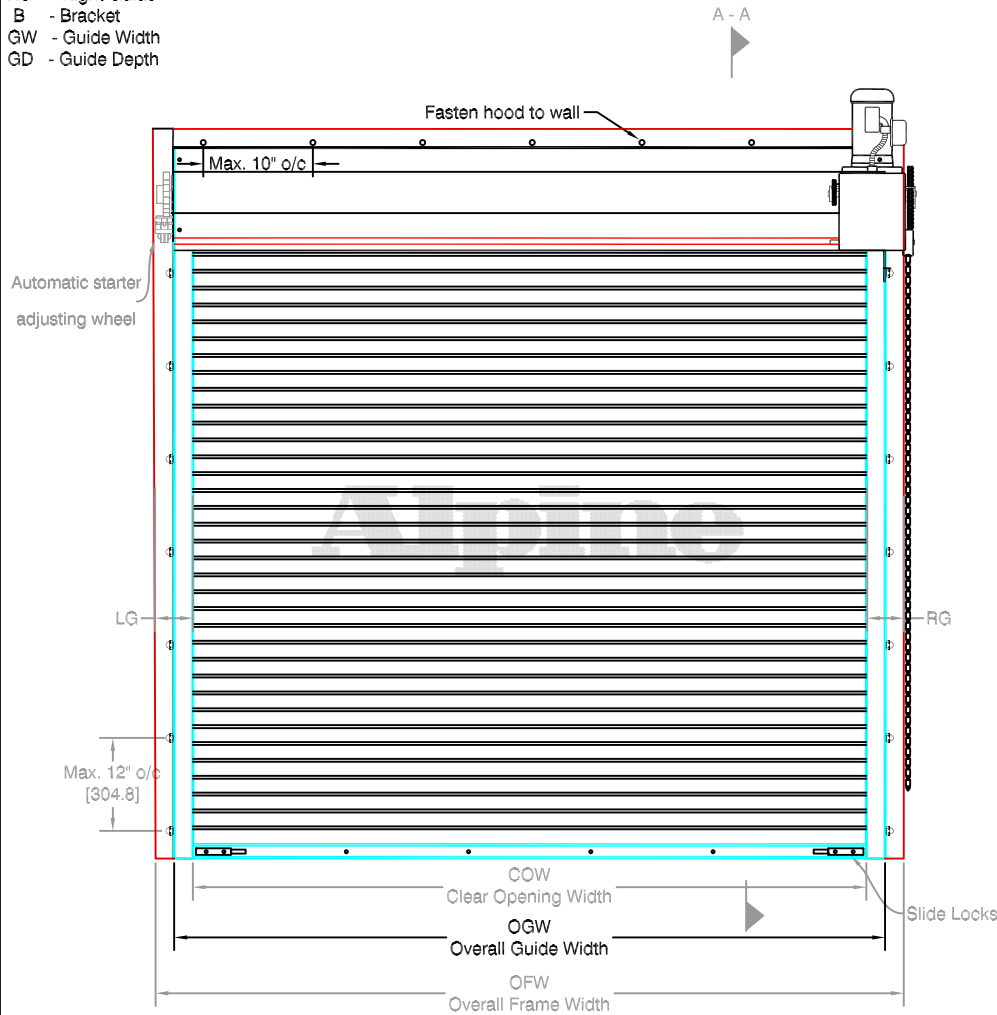

COIL SIDE ELEVATION

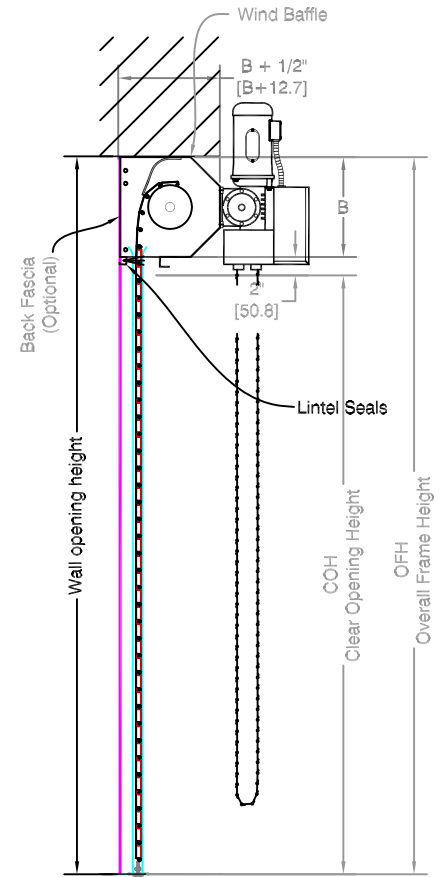

VERTICAL SECTION A - A

STEEL MOUNTED

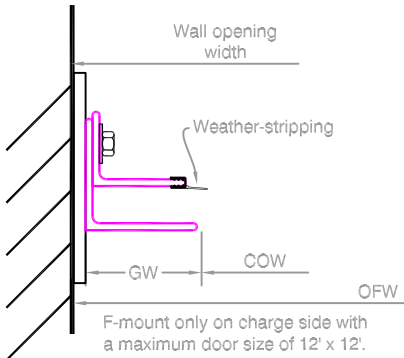

PACKOUT MOUNTED

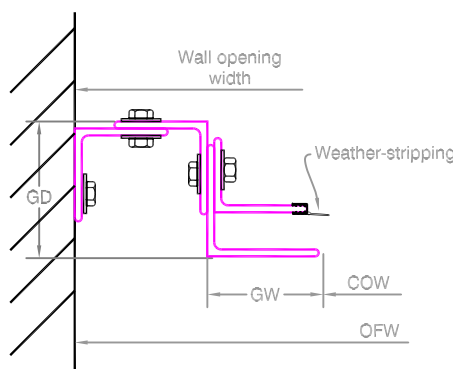

TUBE MOUNTED

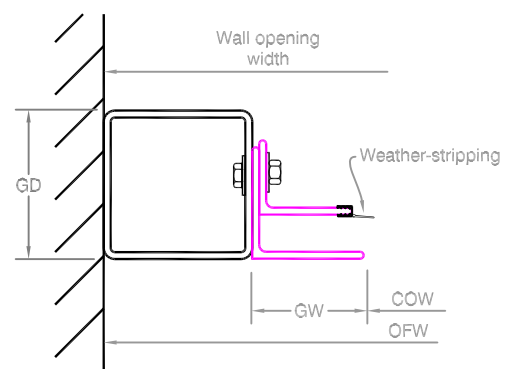

GUIDE SECTION B - B

Notes:

1. See page 2 for more options.
2. All metric conversions of dimensions are shown in brackets [].

SALES REP:

CUSTOMER:

JOB NAME:

NUMBER:

Manufactured by:



8 Hulse Road, East Setauket, NY
 TEL: (718)384-6100 FAX: (718)486-6324
 © COPYRIGHT JANUARY 2001

SOUND RETARDANT DOOR

Insulated Slat

Patent # 5419386 ®
Insul-Sound
 SOUND RETARDANT DOOR

Page#:

Page 2

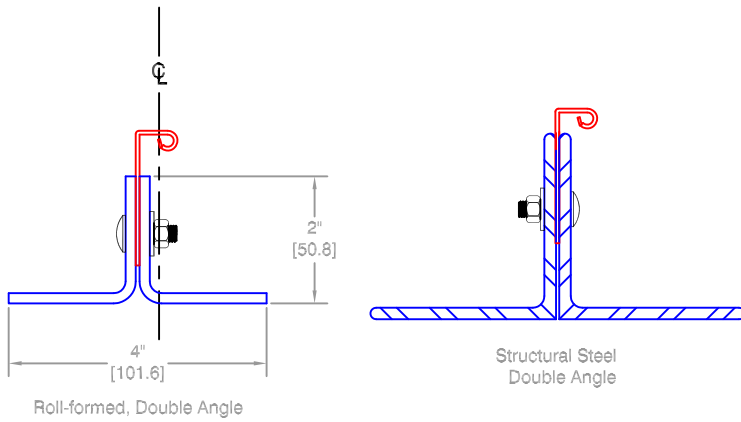

BOTTOM BAR DETAIL

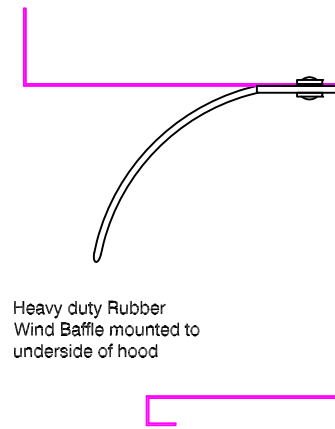

Heavy duty Rubber
 Wind Baffle mounted to
 underside of hood

WIND BAFFLE DETAIL

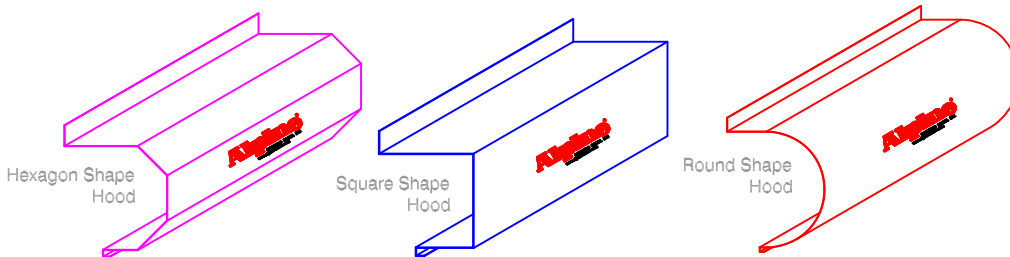

HOOD SHAPES AVAILABLE FOR THIS DOOR

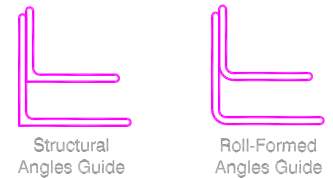

Structural
 Angles Guide

Roll-Formed
 Angles Guide

GUIDE OPTIONS

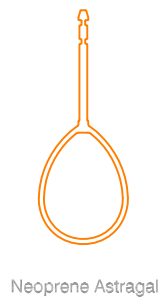
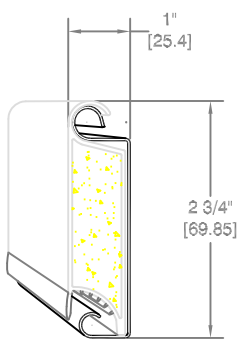

Neoprene Astragal

CURTAIN DETAIL

OBSTACLE EDGES AVAILABLE

Distributed By:

Call your Alpine representative for additional options and safety products to help find the best Alpine door to suit your needs.

Manufactured by:

Alpine®
 OVERHEAD DOORS, INC.
 8 HULSE ROAD EAST SETAUKET, N.Y. 11733
 TEL: (631)473-9300 FAX: (631)642-0800
 © COPYRIGHT MAY 2007

NOTE: MAXIMUM PIPE DEFLECTION ON ANY SIZE DOOR IS .034



Page#:

Page 3

Finding the minimum required operation for the size door you need.

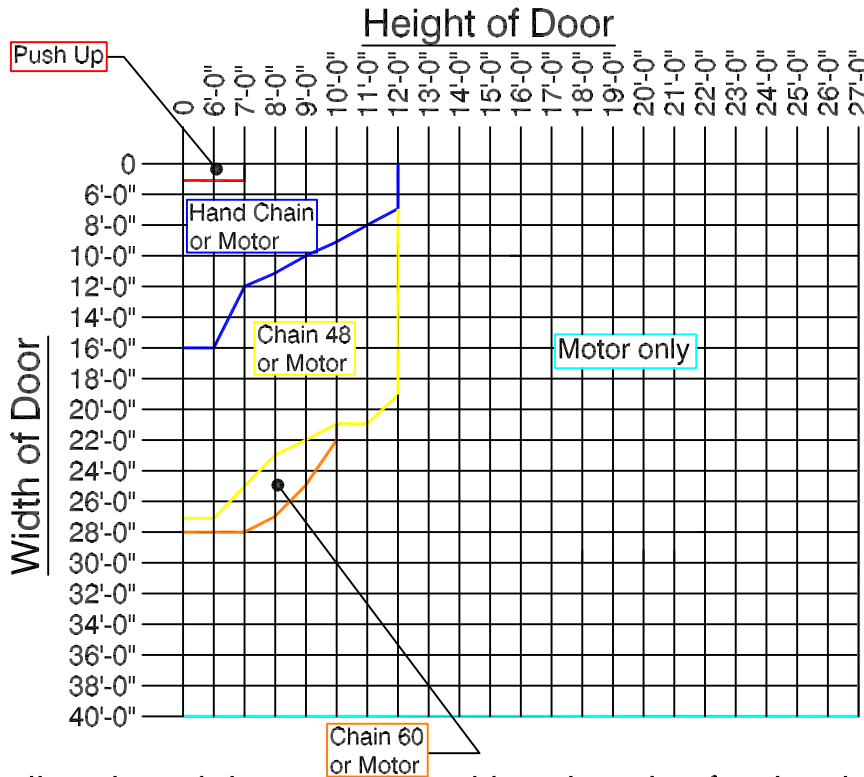

Operator Legend

- Manual Push Up Operation
- Hand Chain Operation
- Hand Chain w/ Gear reduced 48
- Hand Chain w/ Gear reduced 60
- Motor Operation Only

To use Chart: Find where your door width and height meet to find the minimum operation that may be used for that door size.

For example: The blue line indicates a Hand Chain Operation. Any size door on that line or above that line may use a Hand Chain, including the door sizes that fall into the Manual push up door. But, The Manual push up door may not be used for any door size below the line representing Push up operation. For any door size larger than what is represented here please consult your Alpine Overhead Doors, Inc. Factory. This Graph is for reference only, subject to change without notice.

Finding the minimum required bracket size for the door you need.

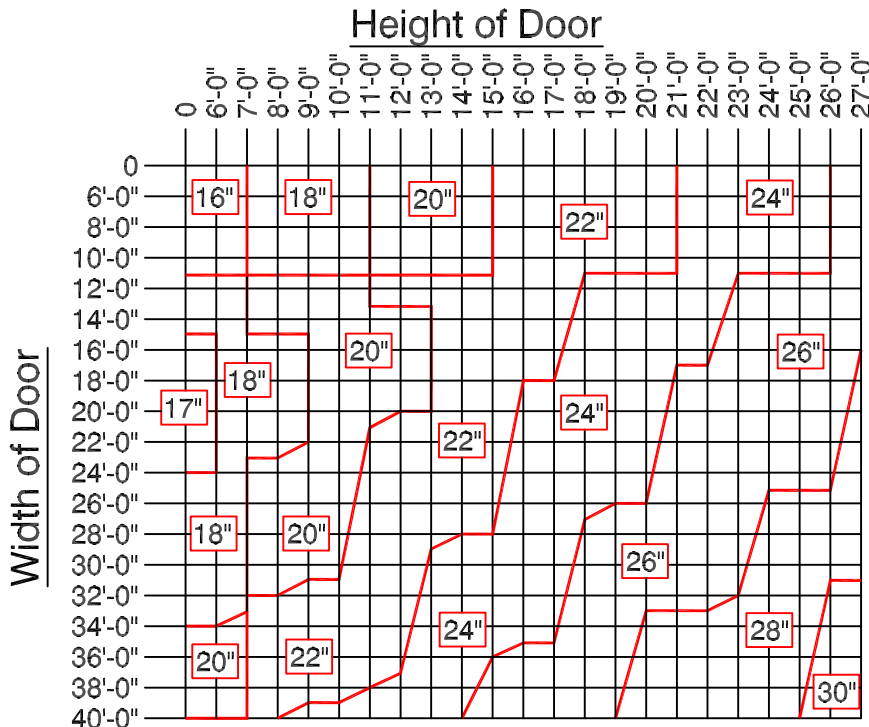

NOTE: Bracket sizes may vary based on gauge of curtain. Bracket size is directly related to the pipe low moment arm deflection (not more than .03 inches per foot).

To use Chart: Find where your door width and height meet to find the minimum bracket size for your door. For any door size larger than what is represented here please consult your Alpine Overhead Doors, Inc. Factory. This Graph is for reference only, subject to change without notice.

Distributed By:

Manufactured by:



8 HULSE ROAD EAST SETAUKET, N.Y. 11733
 TEL: (631)473-9300 FAX: (631)642-0800
 © COPYRIGHT DEC 2006